



Emerson[®]

***0.7 CUBIC FOOT
MICROWAVE OVEN***

***OWNER'S MANUAL
MW8773SL***

Visit our web site at www.emersonradio.com

UNAUTHORIZED MODIFICATIONS TO THIS DEVICE COULD VOID THE USER'S AUTHORITY TO OPERATION

PRECAUTIONS TO AVOID POSSIBLE EXPOSURE TO EXCESSIVE MICROWAVE ENERGY

- (a) Do not attempt to operate this oven with the door open since open-door operation can result in harmful exposure to microwave energy.
It is important not to defeat or tamper with the safety interlocks.
- (b) Do not place any object between the oven front face and the door or allow soil or cleaner residue to accumulate on sealing surfaces.
- (c) Do not operate the oven if it is damaged.
It is particularly important that the oven door closes properly and that there is no damage to the following: (1) door (bent), (2) hinges and latches (broken or loosened), (3) door seals and sealing surfaces.
- (d) The oven should not be adjusted or repaired by anyone except properly qualified service personnel.

CONTENTS

Precautions to Avoid Possible Exposure to Microwave Energy.....	1	To Stop the Oven While it is Operating	15
Important Safety Instructions.....	2	Cooking Guide.....	16
Safety Precautions	3	The Principles of Microwave Cooking	16
Grounding Instructions	5	Food Characteristics	16
Installation	5	Microwave Techniques.....	16
Care of Your Microwave Oven	6	Hot Snacks and Appetizers	17
How to Use Your Microwave Oven Safely	6	Meats.....	18
Location of Controls	7	Poultry	19
Operation.....	8	Seafood.....	19
Setting the Clock	8	Eggs & Cheese	20
Defrost By Weight	8	Vegetables and Soup	21
Speed Defrost	9	Sauces	22
Cooking In One Stage	9	Casseroles	22
2 Stage or 3 Stage Time Cooking	9	Sandwiches	23
Start/Stop Pad	9	Pasta and Grains.....	23
Cook By Weight.....	10	Cereals	24
Baked Potato Quick Cook Pad.....	11	Convenience Foods	24
Pizza Quick Cook Pad.....	11	Desserts	25
Popcorn Quick Cook Pad	12	Weight & Measure Conversion Chart.....	25
Setting Popcorn Quick Cook Pad to a Different Time.....	12	Specifications	26
Beverage Quick Cook Pad	13	Before You Call for Service	26
Frozen Dinner Quick Cook Pad.....	13	Limited Warranty	27
Reheat Quick Cook Pad.....	14		
Child Lock.....	14		
Setting the Timer	15		

IMPORTANT SAFETY INSTRUCTIONS

When using electrical appliances, basic safety precautions should be followed, including the following:

- 1 Read all instructions before using this appliance.
- 2 Read and follow the specific "PRECAUTIONS TO AVOID POSSIBLE EXPOSURE TO EXCESSIVE MICROWAVE ENERGY" found on page 1.
- 3 This appliance must be grounded. Connect only to a properly grounded outlet. See "GROUNDING INSTRUCTIONS" found on page 5.
- 4 Install or locate this appliance only in accordance with the provided installation instructions.
- 5 Some products such as whole eggs and sealed containers, for example, closed glass jars, may explode and should not be heated in this oven.
- 6 Use this appliance only for its intended use as described in this manual. Do not use corrosive chemicals or vapors in this appliance. This type of oven is specifically designed to heat, cook, or dry food. It is not designed for industrial or laboratory use.
- 7 As with any appliance, close supervision is necessary when used by children.
- 8 Do not operate this appliance if it has a damaged cord or plug, if it is not working properly, or if it has been damaged or dropped.
- 9 This appliance should be serviced only by qualified service personnel. Contact the nearest authorized service facility for examination, repair or adjustment.
- 10 Do not cover or block any openings on this appliance.
- 11 Do not store or use this appliance outdoors. Do not use this product near water, for example, near a kitchen sink, in a wet basement, or near a swimming pool, and the like.
- 12 Do not immerse cord or plug in water.
- 13 Keep cord away from heated surfaces.
- 14 Do not let cord hang over edge of table or counter.
- 15 When cleaning surfaces of door and oven that come together when closing the door, use only mild, non-abrasive soaps or detergents applied with a sponge or soft cloth.
- 16 To reduce the risk of fire in the oven cavity:
 - (a) Do not overcook food. Carefully attend appliance if paper, plastic, or other combustible materials are placed inside the oven to facilitate cooking.
 - (b) Remove wire twist-ties from paper or plastic bags before placing bag in oven.
 - (c) If materials inside the oven should ignite, keep oven door closed, turn oven off, and disconnect the power cord, or shut off power at the fuse or circuit breaker panel.
 - (d) Do not use the cavity for storage purposes. Do not leave paper products, cooking utensils, or food in the cavity when not in use.
- 17 Do not use this microwave oven to heat corrosive chemicals (for example, sulfides and chlorides). Vapors from such corrosive chemicals may interact with the contact and springs of the safety interlock switches thereby rendering them inoperable.
- 18 Keep the waveguide cover clean at all times. Wipe the oven interior with a soft damp cloth after each use. If you leave grease or fat anywhere in the cavity it may lead to overheating and fire.
- 19 Never heat oil or fat for deep frying as you cannot control the temperature and doing so may lead to overheating and fire.
- 20 Liquids, such as water, coffee, or tea are able to be overheated beyond the boiling point without appearing to be boiling due to surface tension of the liquid. Visible bubbling or boiling when container is removed from the oven is not always present. THIS COULD RESULT IN VERY HOT LIQUIDS SUDDENLY BOILING OVER WHEN A SPOON OR OTHER UTENSIL IS INSERTED INTO THE LIQUID. To reduce the risk of injury to persons:
 1. Do not overheat the liquid.
 2. Stir the liquid both before and halfway through heating it.
 3. Do not use straight-sided containers with narrow necks.
 4. After heating, allow the container to stand in the microwave oven for a short time before removing the container.
 5. Use extreme care when inserting a spoon or other utensil into the container.

SAVE THESE INSTRUCTIONS

SAFETY PRECAUTIONS

General Use

- 1 Do NOT attempt to tamper with or make any adjustments or repairs to door, control panel or any other part of the oven. Do NOT remove outer panel from oven. Repairs should only be done by qualified service personnel.
- 2 Do NOT operate the oven empty. The microwave energy will reflect continuously throughout the oven if no food or water is present to absorb energy.
- 3 If a fire occurs in the oven, touch the Start/Stop pad and LEAVE THE DOOR CLOSED. Disconnect the power cord, or shut off power at the fuse or circuit breaker panel.
- 4 Do NOT attempt to dry clothes, newspapers or other materials in the oven. They may catch on fire.
- 5 Do NOT use recycled paper products. Recycled paper towels, napkins and waxed paper can contain metal flecks which may cause arcing or ignite. Paper products containing nylon or nylon filaments should be avoided, as they may ignite.
- 6 Some styrofoam trays (like those that meat is packaged on) have a thin strip of metal embedded on the bottom. When microwaved, the metal can burn the floor of the oven or ignite a paper towel.
- 7 Avoid inserting nails, wire, etc. through any holes in the unit during operation. Never insert a wire, nail or any other metal objects through the holes on the cavity or any other holes or gaps, because such objects may cause electric shock and microwave leakage.

Utensils

- 1 METAL CONTAINERS or dishes with metallic rims should not be used. Arcing may occur.
- 2 METAL TWIST-TIES may not be used in the microwave oven.
- 3 Do NOT use SEALED JARS or NARROW NECK bottles for cooking or reheating. They may shatter.
- 4 Do NOT use CONVENTIONAL THERMO-METERS in the microwave oven. They may cause arcing.

- 5 Remove PLASTIC STORE WRAPS before cooking or defrosting foods in the oven.
- 6 For FURTHER INFORMATION on proper cooking utensils, refer to the COOKING GUIDE on page 16.

Food

- 1 Never use your microwave oven for HOME CANNING. The oven is not designed to permit proper canning. Improperly canned food may spoil and be dangerous to consume.
- 2 COOKING TIMES given in the cooking guide are approximate. Factors that may affect cooking are starting temperature, altitude, volume, size and shape of food and utensils used. As you become familiar with the oven, you will be able to adjust for these factors.
- 3 It is better to UNDERCOOK RATHER THAN OVERCOOK foods. If food is undercooked, it can always be returned to the oven for further cooking. If food is overcooked, nothing can be done. Always start with minimum cooking times.
- 4 SMALL QUANTITIES of food or foods with LOW MOISTURE content can burn, dry out or catch on fire if cooked too long.
- 5 Do NOT boil eggs in their shell. Pressure may build up and the eggs may explode.
- 6 Potatoes, apples, egg yolks, whole acorn squash and sausage are some examples of food with NONPOROUS SKINS. These must be pierced before cooking to prevent bursting.
- 7 POPCORN must be popped in a microwave corn popper. Microwave popped corn produces a lower yield than conventional popping. Do not use oven for popcorn unless popped in a microwave approved popcorn utensil or unless it's commercially packaged and recommended especially for microwave ovens. Do not use oil unless specified by the manufacturer.
- 8 Do NOT attempt to deep fat fry in your oven.
- 9 HEATED LIQUIDS can ERUPT if not mixed with air. Do not heat liquids in your microwave oven without first stirring.

SAVE THESE INSTRUCTIONS

SAFETY PRECAUTIONS

FEDERAL COMMUNICATIONS COMMISSION RADIO FREQUENCY INTERFERENCE STATEMENT

WARNING:

This equipment generates and uses ISM frequency energy and if not installed and used properly, that is in strict accordance with the manufacturer's instructions, may cause interference to radio and television reception.

It has been type-tested and found to comply with limits for an ISM Equipment pursuant to part 18 of FCC Rules, which are designed to provide reasonable protection against such interference in a residential installation.

However, there is no guarantee that interference will not occur in a particular installation. If this equipment does cause interference to radio or television reception, which can be determined by turning the equipment off and on, the user is encouraged to try to correct the interference by one or more of the following.

- Reorient the receiving antenna of radio or television.
- Relocate the Microwave oven with respect to the receiver.
- Move the microwave oven away from the receiver.
- Plug the microwave oven into a different outlet so that microwave oven and receiver are on different branch circuits.

THE MANUFACTURER is not responsible for any radio or TV interference caused by UNAUTHORIZED MODIFICATION to this microwave oven. It is the responsibility of the user to correct such interference.

ARCING

If you see arcing, press **START/STOP** button and correct the problem.

Arcing is the microwave term for sparks in the oven.

Arcing is caused by:

- Metal or foil touching the side of the oven.
- Foil not molded to food (upturned edges act like antennas).
- Metal, such as twist-ties, poultry pins, or gold rimmed dishes, in the microwave.
- Recycled paper towels containing small metal pieces being used in the microwave.

DO NOT LEAVE OVEN UNATTENDED WHILE COOKING!

SAVE THESE INSTRUCTIONS

GROUNDING INSTRUCTIONS

This appliance must be grounded. In the event of an electrical short circuit, grounding reduces the risk of electric shock by providing an escape wire for the electric current. This appliance is equipped with a cord having a grounding wire with a grounding plug. The plug must be inserted into an outlet that is properly installed and grounded.

WARNING: Improper use of the grounding plug can result in a risk of electric shock. Consult a qualified electrician or service person if the grounding instructions are not completely understood, or if doubt exists as to whether the appliance is properly grounded.

If it is necessary to use an extension cord, use only a three wire extension cord that has a three blade grounding plug, and a three slot receptacle that will accept the plug on the appliance. The marked rating of the extension cord should be equal to or greater than the electrical rating of the appliance.

INSTALLATION

- 1. Steady, flat location:** When positioning the microwave oven, it should be set on a steady, flat surface.
- 2. Ventilation:** Do not block air vents. If they are blocked during operation, the oven may overheat and eventually cause oven failure. For proper ventilation, keep three inches of space between the oven's top, sides, rear and the area where the unit is to be installed.
- 3. Radio and TV reception:** Poor television reception and radio interference may result if the oven is located close to a TV, radio, antenna, or antenna wire. Position the oven as far from them as possible.
- 4. Temperature and moisture:** Keep the oven away from hot air, steam or splashing liquids when choosing a place to locate it, otherwise, the unit's operation may be adversely affected, causing it to break down.
- 5. Power supply:**
 - Check your local power source. This microwave oven requires a 120V, 60Hz power supply.
 - Use a receptacle that will accept the ground prong.
 - A. A short power supply cord is provided to reduce the risks resulting from becoming entangled in or tripping over a longer cord.
 - B. Longer cord sets or extension cords are available and may be used if care is exercised in their use.
 - C. If a long cord or extension cord is used, (1) the marked electrical rating of the cord set or extension cord should be at least as great as the electrical rating of the appliance, (2) the extension cord must be a grounding-type 3-wire cord, and (3) the longer cord should be arranged so that it will not drape over the counter top or tabletop where it can be pulled on by children or tripped over unintentionally.
- 6. Examine the oven for any damage such as:** Dents, a misaligned door, broken door or a dent in the cavity. If any of the above are visible, DO NOT INSTALL THE UNIT. Notify the dealer immediately.

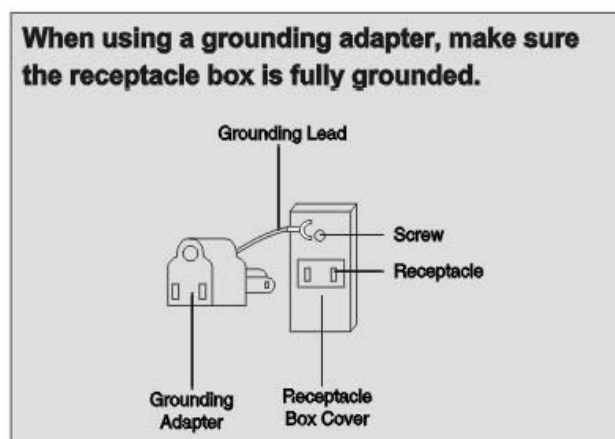

CARE OF YOUR MICROWAVE OVEN

- 1 Disconnect the AC plug from the outlet before cleaning.
- 2 Keep the inside of the oven clean. When food spatters or spilled liquids adhere to oven walls, wipe with a damp cloth. Mild detergent may be used if the oven gets very dirty. The use of harsh detergent or abrasives is not recommended.
- 3 The outside oven surface should be cleaned with soap and water, rinsed and dried with a soft cloth. To prevent damage to the operating parts inside the oven, water should not be allowed to seep into the ventilation slots.
- 4 If the Control Panel becomes dirty or wet, clean with a soft, dry cloth. Do not use harsh detergents or abrasive on Control Panel.
- 5 If steam accumulates on both sides of the oven door, wipe with a soft cloth. This may occur when the microwave oven is operated under high humidity conditions and this is not an indication of a malfunction in the unit.

- 6 It is occasionally necessary to remove the glass tray for cleaning. Wash the tray in warm, sudsy water or in a dishwasher.

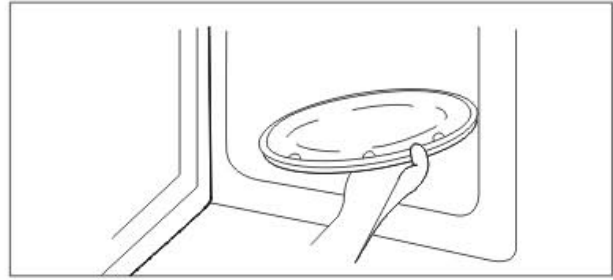

- 7 The roller guide and oven cavity floor should be cleaned regularly to avoid excessive noise. Simply wipe the bottom surface of the oven with mild detergent water or window cleaner and dry. The roller guide may be washed in mild, sudsy water or the dishwasher.

Roller Guide

- 1 The ROLLER GUIDE and oven floor should be cleaned frequently to prevent excessive noise.
- 2 The ROLLER GUIDE MUST ALWAYS be used for cooking together with the Glass Tray.

Glass Tray

- 1 Do NOT operate the oven without the Glass Tray in place.
- 2 Do NOT use any other Glass Tray with this oven.
- 3 If the Glass Tray is hot, ALLOW IT TO COOL before cleaning it or placing it in water.
- 4 Do NOT cook directly on the Glass Tray.

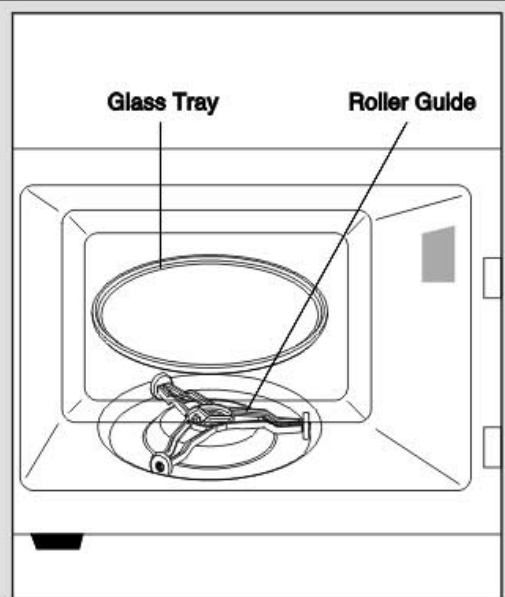

HOW TO USE YOUR MICROWAVE OVEN SAFELY

Although your oven is provided with safety features, it is important to observe the following:

- a) It is important not to defeat or tamper with safety interlocks.
- b) Do not place any object between the oven face and the door or allow residue to accumulate on sealing surfaces. Wipe the sealing area frequently with a mild detergent, rinse and wipe dry. Never use abrasive powders or pads.
- c) When opened, the door must not be subjected to strain, for example, a child hanging on an open door or any load which could cause the oven to fall forward and cause injury and damage to the door. Do not operate the oven if it is damaged, until it has been repaired by a qualified person. It is particularly important that the oven door close properly and that there is no damage to the following:
 - i) Door (bent), ii) Hinges and Latches (broken or loosened), iii) Door seals and sealing surfaces.
- d) The oven should not be adjusted or repaired by anyone except properly qualified service personnel.

LOCATION OF CONTROLS

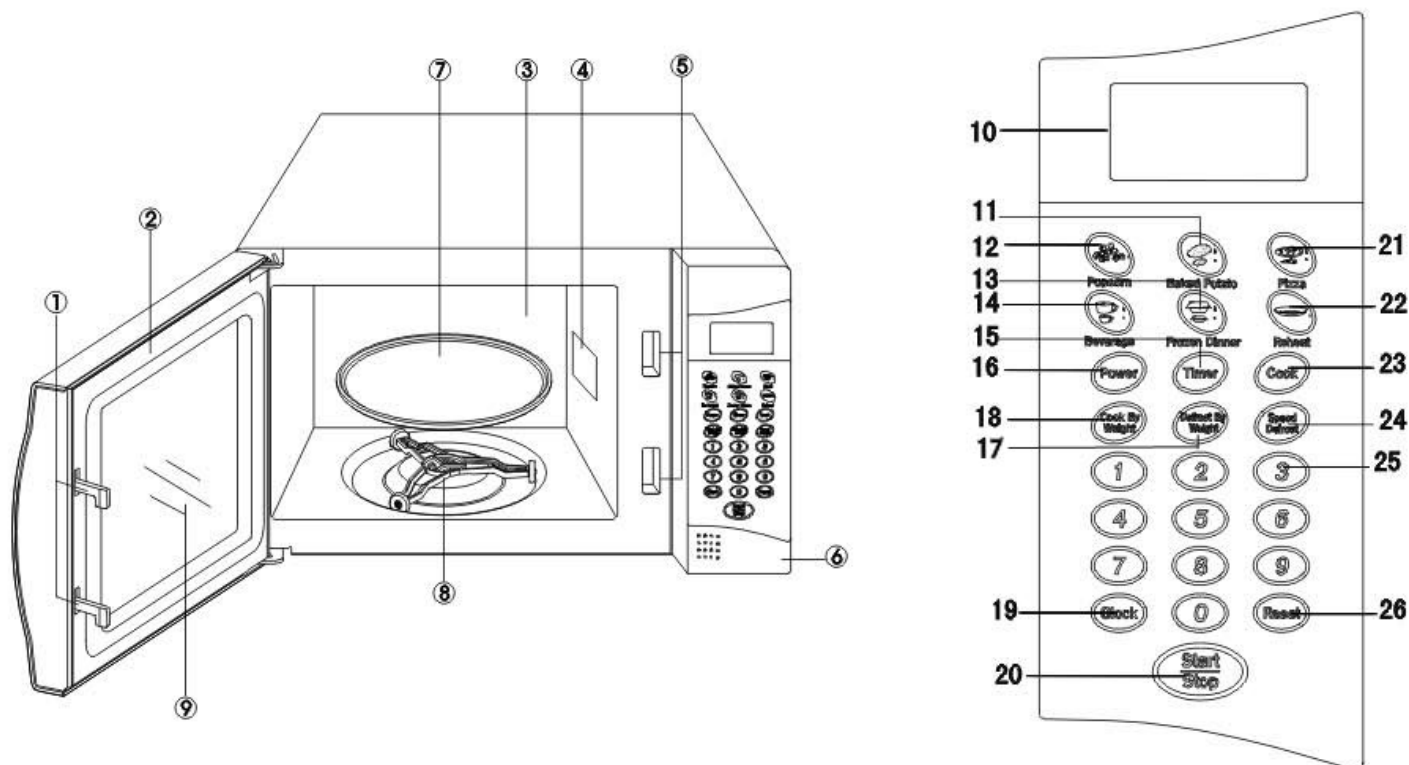

1. Door latch - When the door is closed, it will automatically lock shut. If the door is opened while the oven is operating, the magnetron will automatically shut off.
2. Door seal - The door seal maintains the microwaves within the oven cavity and prevents microwave leakage.
3. Oven cavity
4. Spatter shield - Protects the microwave outlet from splashes of cooking foods.
5. Safety interlock system - Prevents the oven from operating while the door is opened.
6. Door Open button - Press to open the door and stop oven operation.
7. Glass cooking tray - Made of special heat resistant glass. The tray must always be in proper position before operating the oven. Do not cook food directly on the tray.
8. Roller guide - Supports the glass cooking tray. Must always be in proper position before operating the oven.
9. Door screen - Allows viewing of food. The screen is designed so that light can pass through, but not the microwaves.
10. Display - Cooking time, power level, function indicators and the present time are displayed.
11. Baked Potato pad - Touch to cook potatoes.
12. Popcorn pad - Touch to cook popcorn.
13. Frozen Dinner pad - Used to cook frozen dinners.
14. Beverage pad - Used to heat beverages.
15. Timer pad - Used to allow the display to operate as a kitchen timer.
16. Power pad - Used to set the desired cooking power level.
17. Defrost By Weight pad - Used to set the oven to estimate the defrosting time by weight entered.
18. Cook By Weight pad - Used to set the oven to estimate the cooking time by weight entered.
19. Clock pad - Touch to set the present time.
20. Start/Stop pad - Used to start or stop a selected operation.
21. Pizza pad - Touch to reheat precooked or cook frozen pizza.
22. Reheat pad - Used to reheat plated foods.
23. Cook pad - Touch to set any desired cook setting.
24. Speed Defrost pad - Automatically divides the defrosting times into periods of alternating defrost and standing times for even defrosting.
25. 10 key pads - Used to select the desired power level, cooking time, etc.
26. Reset pad - Used to reset the cooking data if pressed before cooking starts.

OPERATION

SETTING THE CLOCK

1. Touch the **CLOCK** pad.

The display will show "ENTER CLOCK TIME".

NOTE: When the unit is first plugged in, it will temporarily be in the clock set mode.

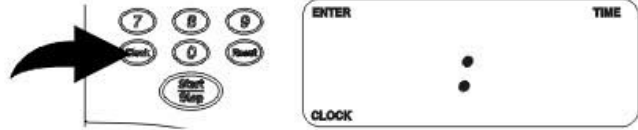

2. Enter the correct time of day.

EXAMPLE: To set the time to "10:02", touch "1", "0", "0", "2" in sequence.

The display will show the numbers pressed in the order in which you pressed them.



3. Touch the **CLOCK** pad.

The display will show the present time and the colon will stop blinking. After the clock has been set, the time will appear unless the oven is cooking or defrosting.



NOTES:

- To reset present time in the display window when the oven is off, touch the **CLOCK** pad and reset.
- A pad must be touched within 15 seconds when setting the clock, or entering cooking information.
- If you make a mistake when setting the time, touch the **RESET** pad.
- To recall the actual time while the oven is cooking or defrosting, simply touch the **CLOCK** pad and the display will show the actual time for three seconds.

DEFROST BY WEIGHT

DEFROST BY WEIGHT lets you easily defrost foods by eliminating guesswork in determining defrosting time. The minimum weight for Auto Weight Defrost is 1oz. The maximum weight is 6.0 lbs (entered as 5lbs, 16oz). Follow the steps below for easy defrosting.

IMPORTANT NOTE: After partial defrosting, the oven will stop defrosting and beep two times, but the time will remain on the display. This pause is to allow you to turn and rearrange the food for even defrosting. After the food is turned and rearranged, press the **START/STOP** pad again.

1. Touch the **DEFROST BY WEIGHT** pad.



2. Using the keypads, enter the pounds, and then enter the ounces.

For example, for 1 pound 5 ounces, touch "1", "0", "5". (Maximum weight that can be entered is 5lbs, 16oz.)

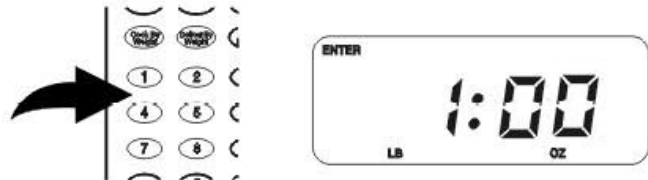

3. Touch the **START/STOP** pad. The display will show "CODE" and "DEF" and count down the remaining defrosting time in minutes and seconds. It will beep four times and show "End" when defrosting is completed (refer to **Important Note above**). Touch the **RESET** pad or open the door to clear before starting another operation.



OPERATION (CONTINUED)

SPEED DEFROST

SPEED DEFROST will automatically set the oven to defrost at a time set by the user. This method provides the quickest thawing of small to medium size foods.

1. Touch the **SPEED DEFROST** pad.

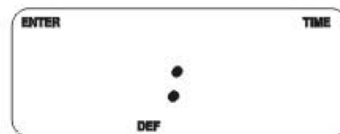
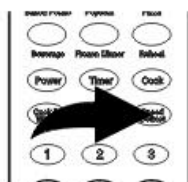

2. Using the key pads, enter the desired defrosting time (up to 99 minutes, 99 seconds).



3. Touch the **START/STOP** pad. The display will show "DEF" and count down the remaining defrosting time in minutes and seconds. It will beep four times and show "End" when defrosting is completed. Touch the **RESET** pad or open the door to clear before starting another operation.

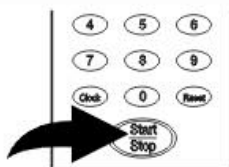

COOKING IN ONE STAGE

Set a cooking or other operational time/power as follows:

1. Using the key pads, enter the desired cooking time (up to 99 minutes, 99 seconds).

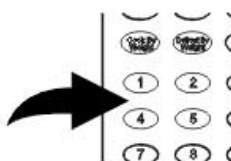

2. Touch the **POWER** pad followed by a key pad to enter the power level (skip if cooking at 100%); see below. The display will show the percentage you chose.



3. Touch the **START/STOP** pad. The display will show "COOK" and count down the remaining cooking time in minutes and seconds. It will beep four times and show "End" when cooking is completed.

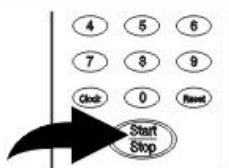

Touch the **RESET** pad or open the door to clear before starting another operation.

2 STAGE OR 3 STAGE TIME COOKING

For two stage cooking, instead of performing step 3, press the **COOK** pad and repeat steps 1 and 2 and then press the **START/STOP** pad; "MEM" will appear in the display.

If desired, after setting two-stage cooking, press the **SPEED DEFROST** pad and enter the desired defrosting time, then press the **START/STOP** pad.

When all stages have completed, four beeps will sound.

START/STOP PAD

To add a minute while the oven is cooking, simply press the **START/STOP** pad. (Works only in Time Cooking and Speed Defrost.)

WATTAGE OUTPUT CHART

Number Pad	% of Power
None	100
9	90
8	80
7	70
6	60
5	50
4	40
3	30
2	20
1	10

OPERATION (CONTINUED)

COOK BY WEIGHT

COOK BY WEIGHT lets you easily roast meats in the oven as it will automatically set the times and power levels to give better results than one power only cooking. Meat must be defrosted and at refrigerated temperature. Meat Roasts approximately three to five pounds work best.

1. Touch the **COOK BY WEIGHT** pad.
The display will show "ENTER CODE".

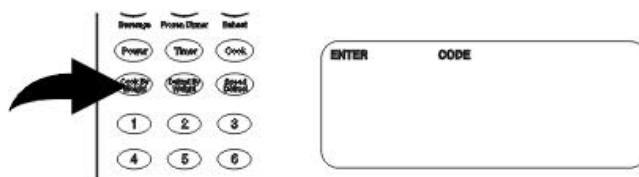

2. Using the key pads, select the desired code that corresponds to the type of food you are cooking according to the chart at the right.

Code	Type	Int. Temp after Standing	Recommended Max Weight
1	Beef	Rare 140°	5lb, 16oz
2	Mutton	Medium 160°	5lb, 16oz
3	Pork	Well Done 170°	5lb, 4oz

3. Using the key pads, enter the pounds, then enter the ounces. For example, for 1 pound 5 ounces, touch "1", "0", "5". (Maximum ounces that can be entered is 16.)
The cooking time will appear.

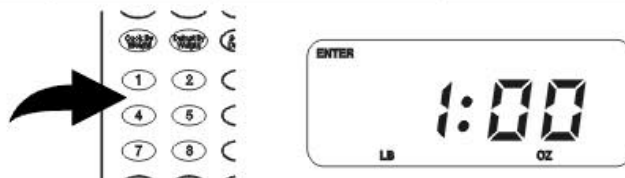

4. Touch the **START/STOP** pad.
The display will show "CODE" and "COOK" and will count down the remaining cooking time in minutes and seconds and will beep four times when cooking is completed. Touch the **RESET** pad or open the door to clear before starting another operation.



NOTES:

- After partial cooking, the oven will stop cooking and beep two times, but the time will remain on the display. This pause is to allow you to turn and rearrange the food for even cooking. After the food is turned and rearranged, press the **START/STOP** pad again.
- Let the roast stand a few minutes to finish cooking before serving

OPERATION (CONTINUED)

BAKED POTATO QUICK COOK PAD

Use this feature and the oven will automatically set the cooking time based on the quantity of potatoes. A built-in standing time will help equalize the temperature. Cook potatoes as follows:

- For 3.5 to 4 ounce potatoes, touch the **BAKED POTATO** pad once. For a 6 to 8 ounce potato, touch the **BAKED POTATO** pad twice. The display will show "ENTER AMT".
* Pierce skins before cooking.

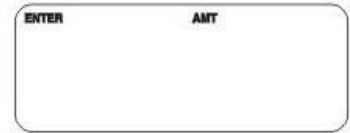
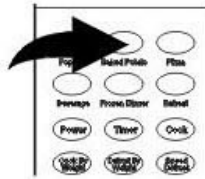

- Enter the amount of four to five ounce potatoes (up to four) and the cooking time will appear. Touch the **START/STOP** pad. The display will show "CODE" and "COOK" and will count down the remaining cooking time in minutes and seconds and will beep four times when cooking is completed.

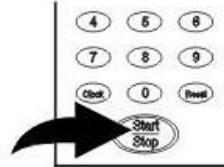

NOTE: Up to four baked potatoes can be cooked as follows:

Qty	3.5 - 5 Oz Times	6 - 8 Oz Times
1 Potato	4 minutes, 20 seconds	6 minutes, 25 seconds
2 Potatoes	8 minutes, 10 seconds	12 minutes, 00 seconds
3 Potatoes	12 minutes, 00 seconds	17 minutes, 00 seconds
4 Potatoes	16 minutes, 00 seconds	22 minutes, 00 seconds

PIZZA QUICK COOK PAD

Use this feature and the oven will automatically set the cooking time based on the the type of pizza (reheated or frozen). Cook pizza as follows:

- To reheat a thick slice or two smaller slices, touch the **PIZZA** pad once (total cooking time is 1 minute 20 seconds). For a whole frozen pizza, touch the **PIZZA** pad twice (total cooking time is 6 minutes 30 seconds). The display will show "CODE".

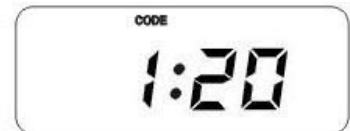
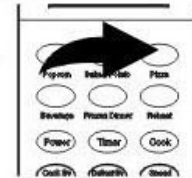

- Touch the **START/STOP** pad. The display will show "CODE" and "COOK" and will count down the remaining cooking time in minutes and seconds and will beep four times when cooking is completed.

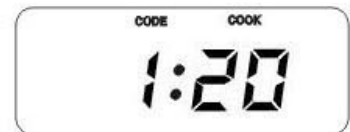
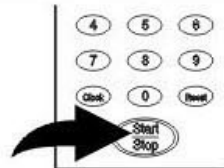

OPERATION (CONTINUED)

POPCORN QUICK COOK PAD

Use this feature and the oven will automatically set the cooking time. Cook popcorn as follows:

1. To cook a standard 3 to 3-1/2 oz bag, touch the **POPCORN** pad (total cooking time is 2 minutes, 50 seconds).
The display will show "CODE".

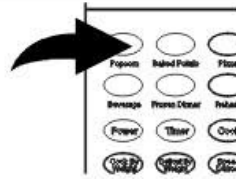

2. Touch the **START/STOP** pad. The display will show "CODE" and "COOK" and will count down the remaining cooking time in minutes and seconds and will beep four times when cooking is completed.

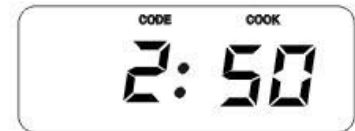
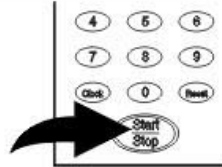

SETTING POPCORN QUICK COOK PAD TO A DIFFERENT TIME

If using a smaller or larger popcorn package, you can automatically set this oven to a different preset popcorn time. If you do change the popcorn time, the oven will continue using the new time each time the **POPCORN** pad is touched. Change the popcorn cooking time as follows:

1. Touch the **POPCORN** pad twice.
The display will show "ENTER TIME".

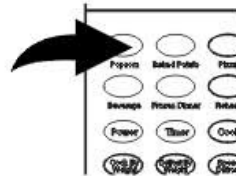

2. Enter a new popcorn time using the Key pads. Touch the **START/STOP** pad to cook the popcorn using the new time.

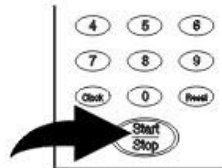

- NOTES:**
1. To avoid discoloration of the glass tray, set the popcorn packages on a microwaveable plate.
 2. Use only a microwaveable popcorn package in the microwave oven.
 3. Do not try to pop unpopped kernels.
 4. Do not leave the oven unattended while popping popcorn. If the popcorn does not pop sufficiently, do not press the **POPCORN** pad again as the popcorn may burn. Check the popcorn bag for cooking instructions.
 5. When opening the package, face it away from you to avoid contact with any steam released.

OPERATION (CONTINUED)

BEVERAGE QUICK COOK PAD

Use this feature and the oven will automatically set the cooking time based on the the size and quantity of the beverage. Cook beverage as follows:

- To heat four to six ounce beverage(s), touch the **BEVERAGE** pad once. To heat seven to nine ounce beverage(s), touch the **BEVERAGE** pad twice. The display will show "ENTER AMT".

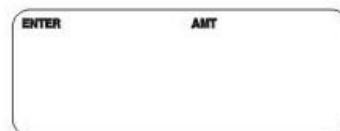
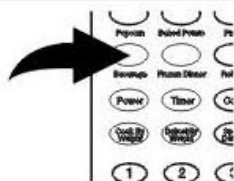

- Enter the amount of cups (up to four) and the cooking time will appear. Touch the **START/STOP** pad. The display will show "CODE" AND "COOK" and will count down the remaining cooking time in minutes and seconds and will beep four times when cooking is completed.

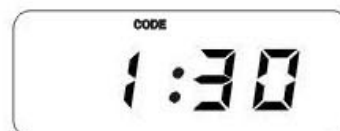
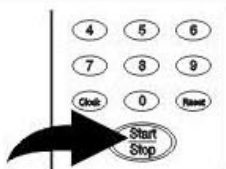

NOTE: Up to four cups can be reheated as follows:

Qty	4-6 Oz Times	7-9 Oz Times
1 Cup	1 minutes,30 seconds	2 minutes,40 seconds
2 Cups	2 minutes,50 seconds	4 minutes,30 seconds
3 Cups	4 minutes,10 seconds	6 minutes,20 seconds
4 Cups	5 minutes,30 seconds	8 minutes,10 seconds

FROZEN DINNER QUICK COOK PAD

Use this feature and the oven will automatically set the cooking time based on the size and quantity of the frozen dinners. A built-in standing time will help equalize the temperature. Cook frozen dinners as follows:

- To heat five to seven ounce frozen dinner(s), touch the **FROZEN DINNER** pad once. To heat eight to 10 ounce frozen dinner(s), touch the **FROZEN DINNER** pad twice. The display will show "ENTER AMT".

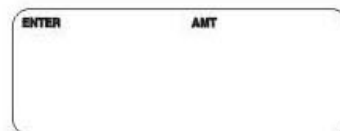

- Enter the amount of frozen dinners (up to two) and the cooking time will appear. Touch the **START/STOP** pad. The display will show "CODE" and "COOK" and will count down the remaining cooking time in minutes and seconds and will beep four times when cooking is completed.

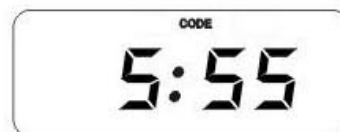
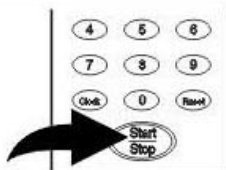

NOTE: Up to two dinners can be reheated as follows:

Qty	5-7 Oz Times	8-10 Oz Times
1 Entree	5 minutes,55 seconds	12 minutes,00 seconds
2 Entrees	11 minutes,00 seconds	20 minutes,00 seconds

OPERATION (CONTINUED)

REHEAT QUICK COOK PAD

Use this feature and the oven will automatically set the cooking time. Reheat as follows:

1. To reheat a standard plate, touch the **REHEAT** pad (total reheat time is 4 minutes, 10 seconds). The display will show "CODE".

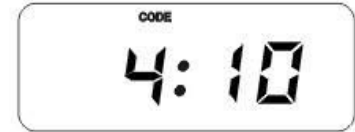
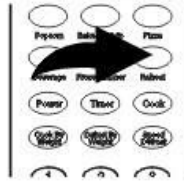

2. Touch the **START/STOP** pad. The display will show "CODE" and "COOK" and will count down the remaining cooking time in minutes and seconds and will beep four times when cooking is completed.

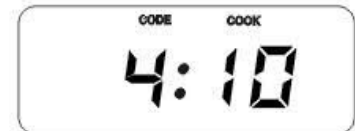
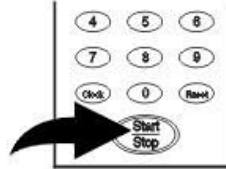

Arranging the foods on the plate will determine how evenly they cook. Dense foods (such as meat) and compact vegetables (such as mashed potatoes) should be placed around the edges and spread out as much as possible to expose them to the microwave energy. Large amounts of food should be spread out to receive more energy than smaller ones. Covering dry meat slices with gravy will help speed the heating. Light, airy foods (such as rice, delicate seafood, etc.) absorb energy quickly. Place them in the center of the plate.

CHILD LOCK

The Child Lock prevents unwanted oven operation by small children. The oven can be set so that the control panel is deactivated or locked.

1. To activate, press and hold the **RESET** pad for three seconds, "LOCK" will appear and no buttons can be pressed.

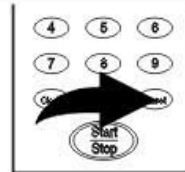

2. To deactivate, press and hold the **RESET** pad for three seconds, "LOCK" will disappear.

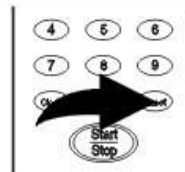

OPERATION (CONTINUED)

SETTING THE TIMER

1. Touch the **TIMER** pad.

The display will show "ENTER TIMER TIME".

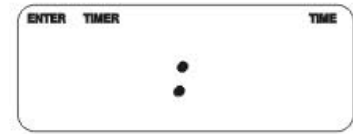
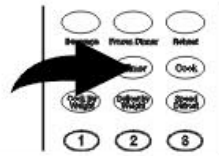

2. Enter the desired timer time.

EXAMPLE: To set the time to "10:02", touch "1", "0", "0", "2" in sequence.

The display will show the numbers pressed in the order in which you pressed them.

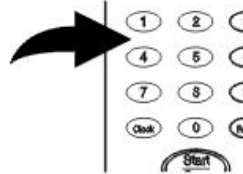

3. Touch the **START/STOP** pad.

The display will count down the timer time and emit one long beep.

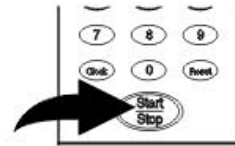

NOTES:

- The clock will appear in the display when the timer is counting down. To view the time left on the timer, simply press the **TIMER** pad once.
- You can set the Timer while the oven is cooking. This is useful to set the timer to go off when you need to turn or rearrange cooking/defrosting foods.
- Touch the **TIMER** pad followed by the **RESET** pad to cancel the timer.

TO STOP THE OVEN WHILE IT IS OPERATING

1. Press the **START/STOP** pad.

- The oven can be restarted by pressing the **START/STOP** pad.
- Touch the **RESET** pad to erase all instructions.
- You must then enter new instructions if needed.

2. Open the door.

COOKING GUIDE

THE PRINCIPLES OF MICROWAVE COOKING

Microwaves are a form of high frequency radio waves similar to those used by a radio including AM, FM and CB. Electricity is converted into microwave energy by the magnetron tube. From the magnetron tube, microwave energy is transmitted to the oven where it is reflected, transmitted, and absorbed by the food.

Reflection

Microwaves are reflected by metal just as a ball is bounced off of a wall. For this reason, metal utensils are not suitable for use in the microwave. A combination of stationary interior walls and a rotating metal turntable or stirrer fan helps assure that the microwaves are well distributed within the oven cavity to produce even cooking.

Transmission

Microwaves pass through some materials such as paper, glass and plastic much like sunlight shining through a window. Because these substances do not absorb or reflect the microwave energy, they are ideal materials for microwave oven cooking containers.

Absorption

During cooking, microwaves will be absorbed by food. They penetrate to a depth of about 3/4 to 1 1/2 inches. Microwave energy activates the molecules in the food (especially water, fat and sugar), and heat is produced. If you vigorously rub your hands together, you will feel heat produced by friction. The internal cooking of larger foods is done by conduction as the heat which is produced by friction is conducted to the middle of the food. Foods also continue to cook by conduction during standing time.

FOOD CHARACTERISTICS

Quantity: The amount of food placed in a microwave oven has a direct effect on the cooking time. Small amounts of food or liquid require less cooking time than larger amounts of the same substance. As quantity increases, concentration decreases.

Size: Small pieces cook faster than large ones. To speed cooking, cut pieces smaller than two inches (5 cm), so microwaves can penetrate to the middle from all sides. Pieces which are similar in size and shape cook more evenly.

Shape: Many foods are uneven, like a chicken, ribs or broccoli. The thin parts will cook faster than the thick parts, while uniformly thick foods cook evenly. To compensate for irregular shapes, place thin pieces toward the center of the dish and thicker pieces toward the edge of the dish.

Starting Temperature: Frozen or refrigerated foods take longer to cook than foods at room temperature.

Bone and Fat: Because bones conduct heat, the side of the meat the bone is on will cook first, while boneless cuts cook slower but more evenly. Fat attracts microwaves. The middle of these foods are cooked by heat conduction.

Moisture Content: Microwaves are attracted by moisture. Naturally moist foods absorb microwaves better than dry ones. Add a minimum of liquid to moist foods, as excess water slows cooking.

Density: The density of food determines how easily the microwaves can penetrate and how quickly it will cook. Porous foods, like chopped beef or mashed potatoes, microwave faster than dense ones like steak or whole potatoes.

Piercing: Steam builds up pressure in foods which are tightly covered by a skin or membrane. Pierce potatoes, egg yolks and chicken livers to prevent bursting.

MICROWAVE TECHNIQUES

Stirring: Stir foods from outside to center of dish once or twice during cooking to equalize heat and speed microwaving. Foods will not burn or stick, so there's no need to stir constantly as you do in conventional cooking.

Arrangement: Arrange foods with thin or delicate ends, like drumsticks or asparagus spears with the thick or tougher portions to the outside of the dish. The parts which need more cooking will receive more energy, so food will microwave evenly.

Spacing: Individual foods, such as baked potatoes and cupcakes will cook more evenly if placed in the oven an equal distance apart. When possible, arrange foods in a circular pattern. Similarly, when placing foods in a baking dish, arrange around the outside of dish, not lined up next to each other. Food should not be stacked on top of each other.

Rearrangement: Rearrange overlapping areas, like tails of long fish fillets, from top to bottom, and closely packed pieces, like meatballs, from the outside to the center of the dish.

COOKING GUIDE (CONTINUED)

Standing Time: Standing time is especially important in microwave cooking. Microwave energy creates heat in the outer layers of the food. As a result of normal conduction, the food continues to cook for a few minutes after removal from the oven. Letting roasts, large whole vegetables, casseroles and cakes stand to finish cooking allows the middles to cook completely without overcooking, drying or toughening the outsides.

Covering: Covering speeds cooking time, retains moisture, tenderizes, insures even cooking and prevents spattering. Casserole lids or plastic wrap are used for a tighter seal. Vent plastic by turning back one edge at the side of dish to form a narrow slot where excess steam can escape. Various degrees of moisture retention are also obtained by using wax paper or paper towels.

Browning: Microwave energy cooks some foods so quickly that the fats and sugars within the food do not have time to caramelize and give a "browned" appearance. Browning agents do not affect the quality of microwaved foods, but can add color and flavor. For meats and poultry, use bouquet sauce diluted with water or melted butter, soy, Worcestershire, barbecue or steak sauce, a sprinkling of paprika or dry gravy mix; jelly glaze or crumb coating. Frosting and topping finish cakes and breads. Top casseroles at the end of microwaving with grated cheese or crumbs.

Some Foods do not Microwave Well

Eggs in Shells and hard boiled eggs can burst.

Pancakes do not crust, but they reheat well. Fully-prepared, frozen pancakes are available for microwaving.

Deep Fat Frying can cause burns.

Bottles with narrow necks may shatter if heated.

Pop Popcorn only in special microwave poppers. Do not use oil unless specified by the manufacturer, or heat longer than recommended. Never pop popcorn in paper bags or glass utensils or directly on the glass tray.

HOT SNACKS AND APPETIZERS

Hot hors d'oeuvres and appetizers can be prepared very quickly in the oven by the hostess, or individual servings may be prepared by guests.

Many appetizers may be cooked on the serving platter, provided the platter does not have metal trim. A time saver tip - prepare these foods ahead of time, refrigerate or freeze and refresh in the oven at serving time. A plate of appetizers will take only seconds to prepare or refresh.

Cheese melts very rapidly and will toughen if overcooked, so watch foods combined with cheese closely so that overcooking will not occur. As soon as cheese starts to bubble, cooking is completed.

Appetizers that have a crisp pastry exterior are best prepared in a conventional oven.

To prepare appetizers wrapped in bacon, it will be necessary to precook the bacon and then wrap around the foods.

Oysters wrapped in bacon are easier to prepare in the broiler of your conventional range.

Seafood mixtures can be prepared in serving shells as microwave energy will pass through the seafood shells without heating. Aluminum foil should not be used for shells.

If spreads are placed on crackers, care should be taken not to overcook as moisture from the food will cause crackers to become soggy. Crackers used for spreads should be very dry and crisp. This helps avoid sogginess. Heat only until spread is at serving temperature.

The time required to heat all appetizers will depend on the amount of food, and the number and the type of dish selected. Remember the food will become very hot even if the dish is cool. Cheese mixtures retain heat longer when heated with microwave energy.

COOKING GUIDE (CONTINUED)

MEATS

Guide for Cooking Meats

Roasts, chops, hamburgers and small cuts of tender meat cook beautifully in the microwave oven. Most roasts can be cooked rare, medium rare or even well done in less than one hour. Less tender cuts of meat such as pot roast can be simmered fork tender in a sauce or gravy. Tough cuts that require slow cooking will do better in the conventional range or oven. A large piece of meat, especially if the shape is uneven, should be turned over occasionally for uniform roasting.

Meat	Power Level	Cooking Time (per lb)	Standing Time	Special Notes
Beef Roast				
Rare	80	9 - 12min.	10 min.	Turn over after half the time.
Medium	80	10 - 13 min.	10 - 15 min.	
Well	80	11 - 16 min.	10 - 15 min.	
Pork Roast				
Bone-in	80	12 - 15 min.	10 min.	Cover with plastic wrap.
Boneless	80	12 - 15 min.	10 - 15 min.	Turn over after half the time.
Lamb Roast				
Bone-in	Medium 80	7 - 9 min.	10 - 12 min.	Turn over after half the time.
	Well 80	9 - 12 min.	10 - 15 min.	
Boneless	Medium 80	9 - 12 min.	10 - 12 min.	
	Well 80	10 - 14 min.	10 - 15 min.	
Beef Patties (3 1/2 oz) each				
2 patties	100	2-1/2 - 3 min.	5 - 7 min.	Turn over and rearrange after half the time.
4 patties	100	4 - 6 min.	5 - 7 min.	
Meat Loaf (2lbs)				
	100	15 - 18 min.	10 - 12 min.	Cover with wax paper.
Bacon				
Slices (4 strips) (1 slice; weight: 1 oz, length: 11 in.)	100	5 - 7 min.	—	Cover with a microwaveable plastic cover.
Ham				
Slices (1 in. thick) 4 slices	50	7 - 9 min.	5 - 7 min.	Cover with plastic wrap.

COOKING GUIDE (CONTINUED)

POULTRY

Guide for Cooking Poultry

Chicken is one of the most popular foods and microwaving chicken is one of the best uses of your microwave oven. Chicken stays juicy and tender in the microwave oven. However, juiciness prevents browning because chicken crisps and browns only when the skin dries out enough to change color. Standing time is important, because it allows the interior to finish cooking without toughening the delicate breast meat.

Food	Power Level	Cooking Time (per lb)	Standing Time	Special Notes
Roast				
Chicken whole	100	7 - 11 min.	10 - 15 min.	Place breast side up on roasting rack. Let stand, covered, before serving.
Chicken cut up	100	7 - 11 min.	7 - 10 min.	
Turkey	80	7 - 11 min.	10 - 15 min.	
Cornish Hens	100	7 - 11 min.	7 - 10 min.	
Turkey Breast	60	8 - 10 min.	5 - 7 min.	Rearrange once during cooking. Cover with wax paper.

SEAFOOD

Guide for Cooking Seafood

Microwaving is one of the easiest and most efficient ways of preparing fish and seafood, which stay delicate and tender with quick, moist cooking. Overcooking dries out and toughens seafood, so you should check it after the minimum time. If thick pieces like fish steaks or lobster tails are done on the outside, but still slightly translucent in the middle, let them stand for a few minutes; internal heat will complete the cooking.

Food	Power Level	Cooking Time	Standing Time	Special Notes
Whole Fish (1 lb to 1 1/2 lbs)	70	8 - 12 min.	5 min.	Turn over after half the time.
Fish Fillet (1 lb)	70	5 - 9 min.	2 - 3 min.	Turn over after half the time.
Fish Steak 1 inch thick (1 lb)	70	4 - 6 min.	5 - 6 min.	Turn over after half the time. Cover with wax paper.
Shrimp (1 lb)	70	3 - 4-1/2 min.	5 min.	Rearrange once during cooking. Cover with plastic wrap.
Sea Scallops (1 lb)	80	6 - 7-1/2 min min.	5 min.	Rearrange once during cooking. Cover with plastic wrap.

COOKING GUIDE (CONTINUED)

EGGS & CHEESE

Guide for Cooking Eggs & Cheese

- **CHEESE**

Cheese melts quickly and smoothly. When serving cheese as an appetizer, flavor is at peak when served at room temperature. Use a low power level for melting. Cheese melts best when shredded and heated with milk or other liquids. Stir cheese mixtures several times for even heating.

- **EGGS**

Eggs cook differently by microwave. The high fat content of egg yolks absorb energy, so yolks cook faster than whites. It's easy to poach eggs in a microwave oven, but if you want soft yolks, remove eggs from the oven before whites are completely cooked. A brief standing time allows whites to set without overcooking yolks. Check eggs for completion of cooking early, they toughen when overcooked.

When eggs and yolks are mixed together for omelets, scrambled eggs or custards, they cook evenly and need less stirring than the conventional cooking methods.

Do not try to cook eggs in the shell. Steam can build up inside the shells, causing them to burst.

Scrambled Eggs

Eggs	Butter	Milk or Water	Cook on Power 10	Procedure
2	1 Tbsp	2 Tbsp	1 -3min.	Place butter in small casserole and melt. Add eggs and milk, scrambling with fork. Cook as directed in chart, breaking up and stirring eggs twice. Let stand, covered, before serving.
4	1 Tbsp	2 Tbsp	2 - 4 min.	
6	2 Tbsp	4 Tbsp	3 - 5 min.	

Poached Eggs

Eggs	Water	Cook Water on Power 10	Cook Eggs on Power 8	Standing Time	Procedure
1	1 1/2 cups	3 - 5 min.	2 min.	2 min.	Place water into medium casserole. Cook at High until boiling. Break eggs, one at a time, into separate dish, pierce yolk once with wooden pick and slip egg carefully into hot water, cook as directed in chart.
2	1 1/2 cups	3 - 5 min.	2 - 3 min.	2 min.	
4	2 cups	5 - 6 min.	3 - 5 min.	2 min.	

COOKING GUIDE (CONTINUED)

VEGETABLES

Guide for Cooking Fresh Vegetables

Nutrition research indicates that many microwaved vegetables and fruits lose less water soluble vitamin C than when cooked conventionally. This is due to shorter cooking time and to the fact that less cooking water is needed when microwaving fruits and vegetables. Best of all, vegetables keep their fresh color, texture and flavor. Vegetables should be microwaved covered with vented plastic wrap or a casserole lid. Vegetables cooked in their skins, such as potatoes, are already so tightly covered that they should be pricked with a fork before cooking in order to release excess steam. To assure even cooking, vegetables should be cut in uniform pieces and stirred during the cooking time. Always add salt to water before adding vegetables. Reduce time a minute or two for crisp-tender texture. Increase time for very soft texture. Remember to allow standing time of two to five minutes after cooking, because as most foods do, vegetables will continue to cook after they are removed from the microwave oven.

Food	Water Amount	Cook on Power 10	Standing Time	Special Notes
Asparagus				
Spears (1lb)	1/4 cup	5 - 7 min.	2 min.	Medium Casserole. Rearrange once.
Cuts (1lb) 1/2 cup	5 - 6 min.	2-1/2 min.		
Beans				
Fresh green (1/2lb)	1/4 cup	5 - 7 min.	2 min.	Stir twice.
Frozen green (1/2lb)	2 Tbsp	6 - 7 min.	2 min.	Stir twice.
Green Peas (2 cups)	1/4 cup	4 - 6-1/2 min.	2 min.	Small casserole. Stir twice.
Broccoli (2 cups)	1/4 cup	4 - 6-1/2 min.	2 min.	Medium casserole. Rearrange once during cooking.
Brussels Sprouts (1lb)	1/4 cup	7 - 8 min.	2 - 3 min.	Medium casserole. Stir once.
Cabbage (1lb)	1/4 cup	6 - 7-1/2 min.	2 - 5 min.	Rearrange once during cooking.
Cauliflower pieces (1 head)	1/4 cup	6 - 7-1/2 min.	2 - 5 min.	Wrap in plastic wrap. Stir once.
Mushroom slices (1/2lb)	2 Tbsp	4 - 6- min.	2 - 3 min.	Small casserole. Stir once.

SOUPS

Guide for Cooking Soups

Satisfy appetites with savory soups prepared in your microwave oven. Follow our recipes for homemade soups and stews or adapt your favorites by using similar cooking times and techniques.

Food	Power Level	Cooking Time	Standing Time	Special Notes
Canned Condensed				
Cream style, Bean, Pea or Mushroom (10 1/2 - 11 1/2 oz)				
With Water	100	5 -6 min.	2 - 3 min.	Stir halfway through cooking time. Cover.
With Milk	80	5 - 7-1/2 min.	2 - 3 min.	
Dry Soup Mix	100 then	5 - 8min.	2 - 3 min.	Add water. Cover with lid. Stir twice.
1 envelope (10 1/2 oz)	60	2-1/2 - 4 min.		
Broth (10 1/2 oz)	100	4 - 5-1/2 min.	2 - 3 min.	Stir twice. Cover

COOKING GUIDE (CONTINUED)

SAUCES

Guide for Cooking Sauces

Sauces boil over rapidly, especially those that contain milk. As soon as the door is opened, cooking stops. If ingredients are not taken directly from the refrigerator, cooking time will be less than given in the recipe. Stir sauce quickly, about every 30 seconds to eliminate lumps. Be sure to use a container twice the size of the amount of liquid to prevent boiling over.

A wooden spoon may be left in the dish while sauce is cooking for easy stirring. If sauce is stirred slowly, cooking time may require about 15 seconds longer. If desired, a 1 quart glass measure may be used to prepare some sauces.

White Sauce

Amount	Butter	Flour	Milk	Cook Butter	Cook Sauce	Special Notes
1 cup, thin	1 Tbsp	1 Tbsp	1 cup	45 sec.	1-1/2 - 4 min.	Cook on Full power as directed or until thickened, stirring once. Let stand, covered, before serving.
med.	2 Tbsp	2 Tbsp	1 cup	1 min.	1-1/2 - 4 min.	
thick	3 Tbsp	3 Tbsp	1 cup	1 min.	3 - 4-1/2 min.	

Brown Gravy

Amount	Fat from Drippings	Flour	Liquid or Drippings	Cook on Power 10	Special Notes
1 cup, thin	1 Tbsp	1 Tbsp	1 cup	2 - 4 min.	Cook on Full power as directed or until thickened, stirring once. Let stand, covered, before serving.
med.	1 Tbsp	1 Tbsp	1 cup	3 - 5 min.	
thick	1 Tbsp	1 Tbsp	1 cup	3 - 5 min.	

CASSEROLES

Casseroles may require occasional stirring to distribute heat. They cook more evenly when made with ingredients of similar size and shape. Because of their shorter cooking time, casseroles cooked in the microwave oven generally need less liquid. Casseroles with cream and cheese sauces, or meats which need slower cooking to tenderize, cook best on power level 4.

When cooking a favorite casserole, make two and freeze the second for future use. Line a casserole or baking dish with plastic wrap. Transfer the cooked food to the lined container and freeze. As soon as the food is frozen in the shape of the dish, remove it and wrap with freezer paper. Later it can be unwrapped and returned to the container for defrosting and heating.

Dry Casserole Mixtures

Many prepared box type casseroles are available on the grocery shelves. Many have freeze dried foods or evaporated foods included. Cooking periods are so short there may not be time for the foods to absorb the moisture sufficiently and reconstitute the foods. To prepare this type, boil the amount of water recommended on the package. Add the noodles (when included), cover and cook for approximately 10 minutes. Allow noodles to stand covered for an additional 10 minutes, rinse with warm water and drain. Then follow package directions for preparing the mix. Reheat four to six minutes before serving.

COOKING GUIDE (CONTINUED)

SANDWICHES, INCLUDING HAMBURGERS AND HOT DOGS

Guide for Heating Sandwiches

Sandwiches heat very quickly because, being porous, they have a low density. Since the filling is usually more dense than the bread or rolls, the filling determines the heating time. Surprisingly, the filling will always be hotter than the bread feels. Care must be taken not to overcook as the bread will become tough. Use several thin slices of meat. Thin slices heat more quickly and are better than one thick slice. The slow heating thick slice often causes the bread to overcook before the meat is hot. Sandwiches may be placed on a paper plate, napkin or paper towel to be warmed. The sandwich should be covered with a paper towel. Remove wrapping immediately after warming. Already-baked frozen breads and rolls may be used for sandwiches. The filling, however, should be thawed first. Toasted bread is fine for sandwiches and provides a firm base. The toast is warmed only; no further browning occurs.

Food	Amount	Cook on Power 10	Special Notes
Sandwich (6 oz)	1	1 min.	Place on paper towels.
	2	2 - 3 min.	
	4	3 - 5 min.	
Hamburger (4 oz)	1	1 min.	Cover with paper towel.
	4	3 - 5 min.	
Hot Dogs (2 oz)	4	2 - 2-1/2 min.	Cover with paper towel.
Sloppy Joes	4	4-1/2 min.	Place on microwaveable plate.

PASTA & GRAINS

Guide for Cooking Pasta and Grains

Raw long grain rice takes time to rehydrate. Microwaving time is a little shorter than conventional, but the greatest advantage is the ease with which you can prepare fluffy rice without sticking or burning. Cooked rice and pasta reheat easily in the microwave oven without loss of flavor or texture. No extra water is needed to prevent sticking or drying, so there's no danger of overcooking rice and pasta or thinning sauces.

Food	Hot Water	Salt	Oil or Butter	Power Level	Cooking Time	Standing Time
Pasta (8 oz)						
Egg Noodles	4 cups	1 tsp.	1 Tbsp.	100	6 - 8 min.	2 - 5 min.
Macaroni	4 cups	1 tsp.	1 Tbsp.	100	7-1/2 - 10 min.	2 - 5 min.
Spaghetti	4 cups	1 tsp.	1 Tbsp.	100	8 - 11 min.	2 - 5 min.
Lasagna Noodles	4 cups	1 tsp.	1 Tbsp.	100	11 - 14 min.	2 - 5 min.
Rice, Long Grain						
White Rice (1 cup)	2 cups	1 tsp.	1 tsp.	100	5 - 7 min.	5 - 7 min.
				80	9 - 12 min.	
Brown Rice (1 cup)	2 cups	1/2 tsp.	1 tsp.	100	5 - 7 min.	5 - 7 min.
				80	20 - 27 min.	

COOKING GUIDE (CONTINUED)

CEREALS

Microwaved hot cereals can be cooked directly in the cereal bowl and make cleaning up easy.

CONVENIENCE FOODS

Frozen Foods

A large variety of frozen foods, special dishes and dinners are available and the selections continue to increase. The market is changing rapidly, therefore it is impossible to list the foods and types available and recommend cooking procedures. In this book we can only give general directions to assist you.

T.V. Dinners

To prepare a T.V. dinner, follow the maker's instructions for use with microwave ovens. To cook a T.V. dinner will require approximately four to seven minutes for the food to thaw and heat to serving temperature (depending on the types of food). Allow plastic wrap to remain over the dish for two minutes to allow heat to equalize. Dinners that contain mashed potatoes have presented a bit of a problem due to the large compact mass of this particular food. You may want to remove about half the mashed potatoes after defrosting is started, then spread the remaining potatoes over the individual section of the tray. Heat the removed mashed potatoes in an individual dish. For foods that should be crisp when cooking is completed, remove the plastic wrap and use the broiler of a conventional range to crisp the food.

Individual Frozen Foods

These may be commercially prepared or frozen at home. Place the container of frozen food in the oven and heat only until the food starts to defrost and can be removed easily. Empty contents into a casserole or serving dish and continue to defrost and heat. Do not heat foods in deep foil containers. To crisp and brown special toppings, use the broiler of a conventional range. If allowed to heat to serving temperature in a plastic container, the container will warp or melt from the high heat of food.

Frozen Foods in Cooking Pouches or Boilable Bags

To prepare these foods, slit the plastic bag. An X-type cut will help remove the food at the end of cooking time. Place the cut side down on a serving dish (with no metal trim). Heat foods other than vegetables for about three minutes. Frozen vegetables require about nine to 10 minutes of cooking time. Allow the pouch bag to remain over the food for about two minutes to allow time for the heat to equalize. Foods prepared in cheese or white sauce should be removed from the pouch and placed in a glass casserole dish and stirred to prevent overcooking of the sauce around the edges of the dish.

Complete Meals from Table Leftovers

Complete meals from leftovers can be prepared in advance. Foods can be frozen and ready for quick heating in the oven at any time. Choose foods suitable for freezing and put serving portions on paper, glass or china (no metal trim) plates. Wrap with recommended freezer paper and freeze quickly. When apportioning the servings of food on the plate, use approximately the same amount of each kind of food for more even heating. Mashed potatoes will heat quicker if spread slightly and hollowed, with a pat of butter in the center. To prevent small pieces of vegetables, corn, peas, etc., from dehydrating during heating, mound well near the center of the plate.

COOKING GUIDE (CONTINUED)

DESSERTS

There's always time to make dessert with a microwave oven. Fruit desserts have a remarkably fresh flavor and texture. Microwaved cakes are higher and more tender than conventionally baked; since cakes are usually frosted, browning is unimportant. Microwaved pie crusts are exceptionally tender and flaky, while delicate custards and puddings are easy to prepare.

Guide for Cooking Cakes

Food	Power Level	Cooking Time	Standing Time	Special Notes
Cake, round (Mixed 9 inch)	100	6 - 8 1/2 min.	2 - 5 min.	Pour into greased and wax paper lined cake dishes.
	80	7 - 9 min.		
Ring or Angel Food Cake	80	8 - 11 min.	2 - 5 min.	Cover with wax paper.
Muffin (6 muffins)	60	6 1/2- 8 1/2 min.	2 - 5 min.	Rearrange once.
Custard (6 servings)	60	15- 17 min.	5 - 7 min.	Rearrange once.

Baking

- Bar cookies work best. Greasing or lining of the microwaveable baking dish is optional.
- If insufficient browning disturbs you, frost, glaze or add food coloring to white or yellow batters.
- A serviceable microwaveable cookie sheet can be made by covering cardboard with waxed paper.
- Round glass baking dishes, and fluted or smooth microwaveable ring molds work best for cakes. You can make a microwaveable ring mold of your own by placing a medium-size glass in the center of a round glass baking dish.
- Because your cakes will rise higher in microwave cooking, never fill microwaveable cake pans more than half full.
- Reduce baking powder and soda by approximately one-fourth when converting a conventional recipe.
- Fill paper-lined muffin cups to only half full which allows for muffins to rise more than normal.
- You can prepare your own "brown 'n serve" breads and rolls by baking them ahead of time in the microwave oven. Then, place them in a conventional oven to brown prior to serving.
- Breads and rolls should be reheated to the point where they are warm to the touch. Overheating or overcooking makes bread tough and rubbery.
- When making yeast bread in a microwave oven, choose a recipe with cornmeal, whole wheat flour, or rye flour to achieve a richer color.

WEIGHT & MEASURE CONVERSION CHART

• POUNDS & OUNCES TO GRAMS

POUNDS (lbs)	GRAMS (g)	OUNCES (oz)	GRAMS (g)	OUNCES (oz)	GRAMS (g)
1/4	114	1	28	9	255
1/2	227	2	57	10	284
3/4	341	3	85	11	312
1	454	4	113	12	340
2	907	5	142	13	369
3	1361	6	170	14	397
4	1814	7	198	15	425
5	2268	8	227	16	454
6	2722				
7	3175				
8	3629				
9	4082				
10	4536				
11	4990				

• FLUID MEASUREMENTS

1 Cup =	8 fluid ounces =	240 ml
1 Pint =	16 fluid ounces =	480 ml
1 Quart =	32 fluid ounces =	960 ml
1 Gallon =	128 fluid ounces =	3840 ml

SPECIFICATIONS

Item	Rating Specification
Power Supply	120V 15A single phase with grounding 60Hz AC
Microwave Output Power	700W
Microwave Frequency	2450MHz
Outside Dimensions (WxHxD)	17.5"x10.9"x13.5"(445x278x342mm)
Cavity Dimensions (WxHxD)	11 7/8"x8 3/16"x11 3/4"(301x207x298mm)
Weight	Approx.26.4 lbs (12kgs)
Timer	Digital 99 minutes, 99 seconds

BEFORE YOU CALL FOR SERVICE

Refer to the following checklist before you call for service:

The oven does not work:

1. Check that the power cord is securely plugged in.
2. Check that the door is firmly closed.
3. Check that the cooking time is set.
4. Check for a blown circuit fuse or tripped main circuit breaker in your house.
5. Check that the Child Lock feature is not engaged.

Sparking in the cavity:

1. Check the containers, dishes or utensils in the oven and make sure they are not metal or have metal trim.

	TO FIND THE LOCATION AND PHONE NUMBER OF YOUR NEAREST SERVICE CENTER PERMITTED TO PERFORM WARRANTY...
CALL TOLL FREE: 1-800-695-0098	
FOR ADDITIONAL SET-UP OR OPERATING ASSISTANCE PLEASE CALL: 1-800-898-9020	
FOR CUSTOMER SERVICE, PLEASE WRITE TO: Emerson Radio Corp., Consumer Affairs Dept., 5101 Statesman Drive, Irving, TX 75063.	

LIMITED WARRANTY MICROWAVE OVENS

Emerson Radio Corp. Warrants this product to be free from manufacturing defects in original material, including original parts, and workmanship under normal use and conditions ("manufacturing defect") for a period of one (1) year from date of original purchase in, and if used in, the United States ("warranty"). Should service be necessary under this warranty, Emerson will provide the following at an Independent Service Center or Regional Repair Facility permitted by Emerson to perform repairs, provided the manufacturing defect is verified along with the date of purchase:

- * Repair service for one (1) year from date of original purchase at no charge for labor and parts.
- * Replacement of a defective magnetron for seven (7) year from date of original purchase (labor not included after initial twelve (12) months).

There are Independent Service Center and Regional Repair Facilities located through out the country. For one nearest you, DIAL TOLL FREE: 1-800-695-0098. In the event the product must be mailed to a Regional Repair Facility which is permitted by Emerson to perform repairs:

- * Pack the unit in a well-padded heavy corrugated box.
- * Enclose your check or money order payable to the REGIONAL REPAIR FACILITY in the amount of \$ 15.00 to cover return shipping and handling costs.
- * Enclose a copy of your proof of purchase (warranty service will not be provided without dated proof of purchase).
- * Ship the unit prepaid via UPS or parcel post (insured).

NOTE: This warranty does not cover:

- (a) Damage to equipment not properly connected to the product.
- (b) Cost incurred in the shipping of the product to and from a Regional Repair Facility permitted by Emerson to perform warranty repairs.
- (c) Damage or improper operation of unit caused by customer abuse, misuse, negligence, or failure to follow operating instructions provided with the product.
- (d) Ordinary adjustments to the product which can be performed by customer as outlined in the owner's manual.
- (e) Signal reception problems caused by external antenna or cable systems.
- (f) Products not purchased in the United States.
- (g) Damage to product if used outside the United States.

THIS WARRANTY IS NON-TRANSFERABLE AND APPLIES ONLY TO THE ORIGINAL PURCHASER AND DOES NOT EXTEND TO SUBSEQUENT OWNERS OF THE PRODUCT. ANY APPLICABLE IMPLIED WARRANTIES, INCLUDING THE WARRANTY OF MERCHANTABILITY, ARE LIMITED IN DURATION TO A PERIOD OF THE EXPRESSED WARRANTY AS PROVIDED HEREIN BEGINNING WITH THE DATE OF ORIGINAL PURCHASE AT RETAIL AND NO WARRANTIES, WHETHER EXPRESSED OR IMPLIED, SHALL APPLY TO THE PRODUCT THEREAFTER. EMERSON MAKES NO WARRANTY AS TO THE FITNESS OF THE PRODUCT FOR ANY PARTICULAR PURPOSE OR USE.

THE EXTENT OF EMERSON RADIO CORP'S LIABILITY UNDER THIS LIMITED WARRANTY IS THE REPAIR OR REPLACEMENT PROVIDED ABOVE AND, IN NO EVENT, SHALL EMERSON RADIO CORP'S LIABILITY EXCEED THE PURCHASE PRICE PAID BY THE PURCHASER OF THE PRODUCT. UNDER NO CIRCUMSTANCES SHALL EMERSON RADIO CORP. BE LIABLE FOR ANY LOSS, DIRECT, INDIRECT, INCIDENTAL, SPECIAL, OR CONSEQUENTIAL DAMAGE ARISING OUT OF OR IN CONNECTION WITH THE USE OF THIS PRODUCT. THIS WARRANTY IS VALID ONLY IN THE UNITED STATES OF AMERICA.

THIS WARRANTY GIVES YOU SPECIFIC LEGAL RIGHTS. HOWEVER, YOU MAY HAVE OTHER RIGHTS WHICH MAY VARY FROM STATE TO STATE. SOME STATES DO NOT ALLOW LIMITATION ON IMPLIED WARRANTIES OR EXCLUSION OF CONSEQUENTIAL DAMAGE, THEREFORE THESE RESTRICTIONS MAY NOT APPLY TO YOU.

The serial number can be found on the back cabinet. We suggest that you record the serial number of your unit in the space below for future reference.

Model Numer: MW8773SL

Serial Number: _____

MV1094F



EMERSON

PART NO. MW8773-031706-01

Printed in China